

NEW COLLECTIONS
CERSAIE 2023

MUSEUM

MUSEUM

UNIQUE SURFACES

Brand	04
Collections	08
	⑦ <i>LINEN</i> 08
	<i>MATCHA</i> 24
	⑦ <i>NOVA</i> 34
	<i>OULD</i> 46
	<i>VULCANO</i> 58
	⑦ <i>SUPREME</i> 66
MUSEUM Bath	72
Technical Information	80

UNIQUE SURFACES

MUSEUM is the premium porcelain and ceramic brand par excellence.

Products conspicuous for their elegance and sophistication, clearly defined by a strong emphasis on innovation and design. Continued investment in cutting-edge technology allows nature to be brought into spaces, creating surfaces that bring wellness and beauty to any project. Working towards a sustainable future, with a real commitment to the environment and to the generations to come.

MUSEUM es la firma cerámica premium por excelencia.

Elegancia y sofisticación definidas por una fuerte apuesta por el diseño y la innovación. La constante inversión en tecnología permite acercar la naturaleza a los espacios, creando superficies que aportan bienestar y belleza a los proyectos. Trabajando para conseguir un futuro más sostenible, con un compromiso real con el medioambiente y las generaciones venideras.

- | | | | |
|--------------------|--------------------|-----------------|----------------------|
| 1. LINEN Cloud SP | 4. MATCHA Green NT | 7. OUD Taupe AS | 10. OUD Porto AS |
| 2. LINEN Desert SP | 5. NOVA Grey NT | 8. OUD Honey AS | 11. OUD Ebony AS |
| 3. LINEN Mocha SP | 6. OUD Greige AS | 9. OUD Kalua AS | 12. SUPREME White SP |

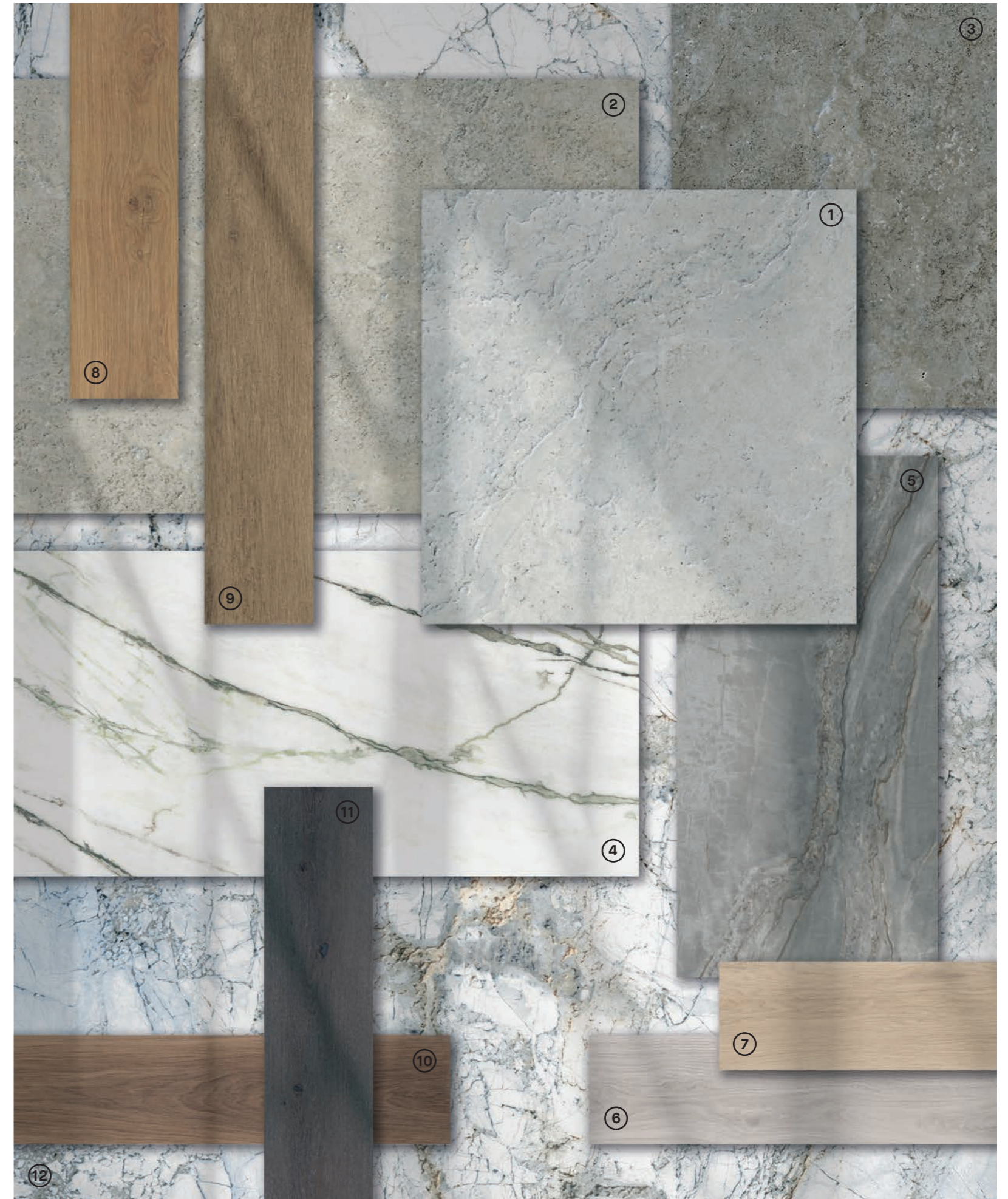

polished (EP)

Polished smooth finish with a deep reflection.
Acabado liso pulido con un profundo reflejo.

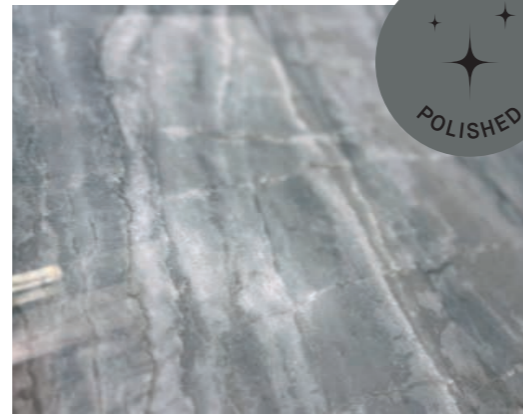

premium polished shimmer (PS)

Sparkly polished finish with a white suspended particles background that provides a sophisticated depth.
Acabado pulido con destellos brillantes, y un efecto de partículas blancas en suspensión que proporcionan una profundidad sofisticada.



NATURAL



natural (NT)

Smooth and soft touch, a matte texture ideal for residential use.
Tacto suave y liso, textura mate ideal para uso residencial.

PREMIUM
POLISHED



premium polished (P)

Polished crystal mirror finish with a perfect reflection.
Acabado pulido con un perfecto reflejo especular.

velvet (VV)

Highly soft finish with a pleasant touch, and also easy to clean.
Acabado muy suave con un tacto agradable, y fácil de limpiar.



shaped (SP)

Smooth texture, the graphic is perfectly coordinated with the relief.
Textura suave, la gráfica se coordina perfectamente con el relieve.



ALL IN ONE
Antislip Soft



all in one (AS)

Unique surface perfect for both indoors and outdoors.
Superficie única perfecta tanto para espacios de interior como de exterior.

ANTISLIP



antislip (A)

Textured surface with matte finish, recommended for outdoor use.
Superficie texturizada mate, recomendada para uso exterior.

LINEN

LINEN is a collection inspired by modern-looking cross-cut *Travertine marble*, with a strong realism and versatile potential uses. One of its most distinctive features is the perpendicular cut of the *Travertine marble* that it emulates, giving rise to a stone surface with rich chromatic variety.

The collection comes in three warm colours (Cloud, Desert and Mocha) in 5 100x275 cm, 100x180 cm, 100x100 cm, 75,5x151 cm, 60x120 cm or 90x90 cm format. It is also available in a Shaped, All in One or Antislip finish, the last in a 20 mm-thick version for outdoor use.

LINEN also features Desert-coloured 12 mm-thick 150x320 cm slabs for use as worktops in a Shaped finish, designed to bring an elegant, modern appeal to kitchens.

LINEN se inspira en un *mármol Travertino* de corte transversal muy contemporáneo, que destaca por su realismo y versatilidad. Una de sus características distintivas es el corte del *Travertino* en forma perpendicular, creando una superficie de aspecto pétreo con amplia riqueza cromática.

Disponible en tres tonalidades cálidas (Cloud, Desert y Mocha) en los formatos 100x275 cm, 100x180 cm, 100x100 cm, 75,5x151 cm, 60x120 cm, 90x90 cm. En una gran variedad de acabados: Shaped, All in One y Antislip, este último disponible como solución de exterior en 20mm.

La colección también cuenta con el formato de encimera de 150x320 cm en 12 mm, en tonalidad Desert y con el acabado Shaped. Esta combinación es perfecta para aportar una estética elegante y moderna en proyectos de cocina.

formats 7
formatos

colours 3
colores

finishes 3
acabados

100 x 275 cm



Finish Acabado



Thickness Espesor

6 mm

100 x 180 cm



Finish Acabado



Thickness Espesor

8 mm

100 x 100 cm



Finishes Acabados



Thicknesses Espesores

8 mm

20 mm

75,5 x 151 cm



Finish Acabado



Thickness Espesor

9 mm

60 x 120 cm



Finish Acabado



Thickness Espesor

9 mm

90 x 90 cm



Finish Acabado



Thickness Espesor

9 mm

Available colours Colores disponibles



Cloud

Desert

Mocha





LINEN CLOUD SP





⊖ LINEN CLOUD 100X100X2/A/R & LINEN CLOUD SP/100X100/C/R ⊕ LINEN CLOUD SP/100X275/C/R



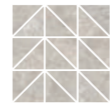

⊖ LINEN CLOUD SP/100X180/C/R ⊕ LINEN CLOUD SP/100X275/C/R

Porcelain Porcelánico							
	100x275 cm 40x109 "	100x180 cm 40x71 "	100x100 cm 40x40 "	75,5x151 cm 30x60 "	60x120 cm 24x48 "	90x90 cm 36x36 "	
Thickness Espesor	6 mm	8 mm	8 mm / 20 mm*		9 mm		
Patterns Gráficas	15	15	15	15	20	15	
CLOUD	Shaped (SP)	38035 M90	37576 M94	37575 M93	-	-	-
	Antislip (A)	-	-	37558* M113	-	-	-
	All in One (AS)	-	-	-	37741 M92	37731 M91	37747 M81
DESERT	Shaped (SP)	38036 M90	37579 M94	37578 M93	-	-	-
	Antislip (A)	-	-	37560* M113	-	-	-
	All in One (AS)	-	-	-	37742 M92	37733 M91	37748 M81
MOCHA	Shaped (SP)	38037 M90	37580 M94	37577 M93	-	-	-
	Antislip (A)	-	-	37559* M113	-	-	-
	All in One (AS)	-	-	-	37743 M92	37732 M91	37749 M81

SPECIAL PIECES PIEZAS ESPECIALES

Porcelain Porcelánico (9 mm)			
D. TRIGEO	30x30 cm 11.8x11.8 "		
	LINEN CLOUD	All in One (AS)	38127 U46
	LINEN DESERT	All in One (AS)	38128 U46
	LINEN MOCHA	All in One (AS)	38129 U46

Porcelain Porcelánico (9 mm)			
* D. HORIZON	30x60 cm 11.8x23.6 "		
	LINEN CLOUD OUD TAUPE	All in One (AS)	38120 U66
	LINEN DESERT OUD HONEY	All in One (AS)	38121 U66
	LINEN MOCHA OUD KALUA	All in One (AS)	38122 U66

Porcelain Porcelánico (9 mm)			
** D. MIX	30x30 cm 11.8x11.8 "		
	LINEN CLOUD LINEN DESERT LINEN MOCHA	All in One (AS)	38125 U51

* D. HORIZON combines cuts with different heights: low pieces (OUD) are 10 mm and high ones are elevated to 13 mm (LINEN).
* D. HORIZON combina cortes a distintas alturas: las piezas bajas (OUD) son 10 mm y las altas (LINEN) se elevan hasta los 13 mm.

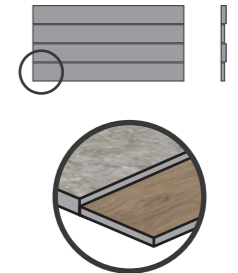

** Random colour position.
** Posición de colores aleatoria.

TECHNICAL DATA DATOS TÉCNICOS

	DIN 51130	DIN 51097	UNE-41901 EX	BS 7976-2 (PTV)	ANSI A137.1 (DCOF)
Shaped (SP)	R9	-	Class 1	-	>0,42
Antislip (A)	R11	A + B + C	Class 3	+36 Wet	>0,42
All in One (AS)	R11	A + B + C	Class 3	+36 Wet	>0,42

150 x 320 cm



Finish Acabado



Thickness Espesor

12 mm

Porcelain Porcelánico

150x320 cm
60x126 "

Thickness Espesor	12 mm
Patterns Gráficas	1
DESERT Shaped (SP)	38020 M107





MATCHA

MATCHA reproduces a select type of *Calacatta Green marble*. It combines all the elegance of *Calacatta marble* with subtle, sophisticated green veins, sometimes even in eye-catching, distinctive shades of lime green.

The collection comes in a 100x275 cm, 100x180 cm, 100x100 cm, 75.5x151 cm or 60x120 cm format in a choice of a Premium Polished, Shaped, Polished or Natural finish.

MATCHA also features 33.3x100 cm decorative wall tiles. Thanks to the use of ground-breaking DEEP TECH technology, added harmony and beauty can be brought to living spaces.

La colección MATCHA representa una exclusiva variedad de *mármol Calacatta Green*, que combina la elegancia del *mármol Calacatta* con un sutil y sofisticado veteado verde, llegando incluso a tonalidades lima de lo más distintivas y cautivadoras.

Disponibile en formatos 100x275 cm, 100x180 cm, 100x100 cm, y también en 75,5x151 cm y 60x120 cm. En acabados Premium Polished, Shaped, Polished y Natural.

Además, incluye un revestimiento decorativo en formato 33,3x100 cm, que gracias a la innovadora tecnología DEEP TECH, permite aportar belleza y armonía en cualquier espacio.

formats 6
formatos

colours 1
colores

finishes 4
acabados

100 x 275 cm



100 x 180 cm



Finish Acabado



Thickness Espesor

8 mm

100 x 100 cm



Finish Acabado



Thickness Espesor

8 mm

75,5 x 151 cm



Finishes Acabados



Thicknesses Espesores

9 mm

60 x 120 cm



Finishes Acabados



Thicknesses Espesores

9 mm

33,3 x 100 cm

White body Pasta blanca



Finish Acabado



Thickness Espesor

10,5 mm



Finishes Acabados



Thicknesses Espesores

13,5 mm

Finishes Acabados



Thickness Espesor

6 mm

The shade of the white body ceramic 33.3x100 cm wall tiles, may vary compared to the porcelain formats.
La tonalidad del revestimiento de pasta blanca 33,3x100 cm, puede variar respecto a los formatos porcelánicos.



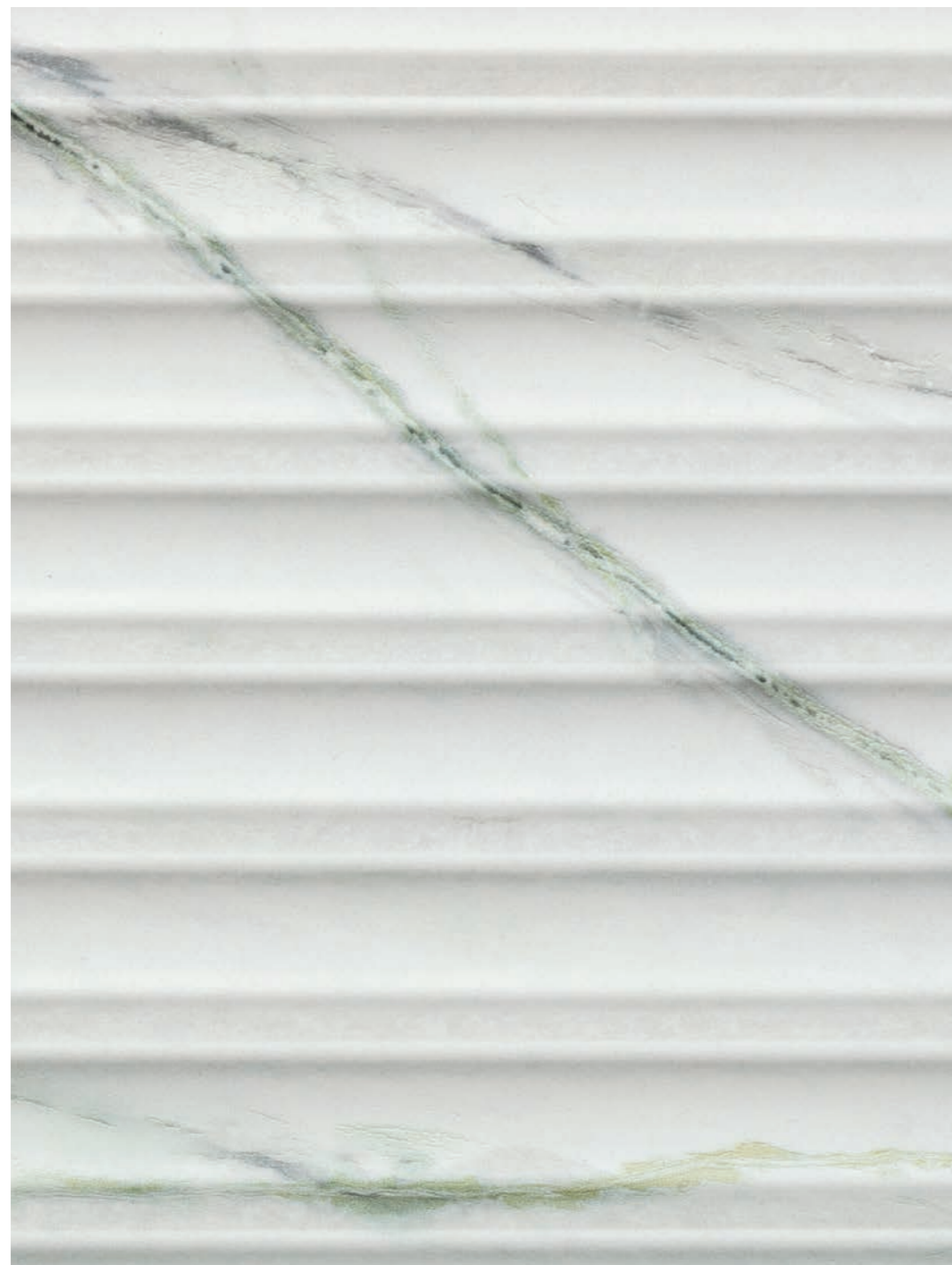

MATCHA GREEN DECOR SP





⊖ MATCHA GREEN SP/100X100/R

Ⓜ MATCHA GREEN DECOR SP/33,3x100/R



		Porcelain Porcelánico			White body Pasta blanca			
		100x275 cm 40x109 "	100x180 cm 40x71 "	100x100 cm 40x40 "	75,5x151 cm 30x60 "	60x120 cm 24x48 "	33,3x100 cm 13x40 "	33,3x100 cm 13x40 " DECOR
Thickness Espesor		6 mm	8 mm		9 mm		10,5 mm	13,5 mm
Patterns Gráficas		9	12	15	15	20	19	19
Premium Polished (P)		38040 M87	-	-	-	-	-	-
Shaped (SP)		38038 M100	38033 M94	38031 M93	-	-	37878 M96	37877 M97
Polished (EP)		-	-	-	37729 M58	37727 M40	-	-
Natural (NT)		-	-	-	37740 M103	37735 M101	-	-

SPECIAL PIECES PIEZAS ESPECIALES

Porcelain Porcelánico (9 mm)

D. MOSAIC		30x30 cm 11.8x11.8 "	
	MATCHA GREEN	Polished (EP)	38115 U36
	MATCHA GREEN	Natural (NT)	38114 U36

Porcelain Porcelánico (9 mm)

D. CHEVRON		30x21,9 cm 11.8x8.6 "	
	MATCHA GREEN OUD EBONY	Polished (EP) All in One (AS)	38113 U55
	MATCHA GREEN OUD EBONY	Natural (NT) All in One (AS)	38112 U55

Porcelain Porcelánico (9 mm)

** D. MIX		30x30 cm 11.8x11.8 "	
	MATCHA GREEN MATCHA GREEN OUD EBONY	Natural (NT) Polished (EP) All in One (AS)	38116 U51

** Random colour position.
** Posición de colores aleatoria.

TECHNICAL DATA DATOS TÉCNICOS

	DIN 51130	DIN 51097	UNE-41901 EX	BS 7976-2 (PTV)	ANSI A137.1 (DCOF)
Shaped (SP)	-	-	Class 1	-	>0,42
Natural (NT)	R10	A + B	Class 2	+36 Wet	>0,42

NOVA

NOVA stands out for its select silver grey stone design: a tribute to the marble used in Ancient Greece to build temples, amphitheatres and monuments. The collection's singular grey hues lend it a timeless distinction, bringing a neutral elegance to living spaces.

One pioneering aesthetic feature of this collection is its Premium Polished Shimmer finish, applied to the 100x275 cm format: a polished surface with a special iridescent effect, combined with what appears to be white particles in suspension. This gives the polished surface greater depth of design, with particle effects that further enhance the superior elegance of its large format.

NOVA also comes in other formats and finishes: 100x180 cm or 100x100 cm in a Shaped finish; 75.5x151 cm in a Polished, Natural or Velvet finish; and 60x120 cm in a Polished or Natural finish.

NOVA has also been added to the MUSEUM ELEVATE range in the form of 12mm-thick 150x320 cm slabs for use as worktops in a Shaped finish, perfect for kitchens in need of a superior touch of elegance.

Sumérgete en la esencia de NOVA y descubre una prestigiosa piedra silver grey. Recuerda los mármoles que se utilizaban en la Antigua Grecia para esculpir templos, teatros y monumentos. Su especial tonalidad gris le ofrece un toque de distinción atemporal, aportando elegancia y neutralidad a los espacios.

Su gran innovación estética es el acabado Premium Polished Shimmer, aplicado al formato 100x275 cm: incorpora un efecto iridiscente en superficie pulida, junto con un efecto matérico de partículas blancas en suspensión. El resultado una superficie pulida con mayor profundidad gráfica, y con efectos matéricos que realzan la elegancia y exclusividad de su gran formato.

También disponible en otros formatos y acabados: 100x180 cm y 100x100 cm Shaped, 75,5x151 cm Polished, Natural y Velvet, 60x120 cm Polished y Natural.

Además, se incorpora a la gama de MUSEUM ELEVATE, en encimera 150x320cm (12mm) de acabado Shaped, para aportar a las estancias de cocinas un toque de lo más premium.

formats 6
formatos
colours 1
colores
finishes 5
acabados

100 x 275 cm



Finishes Acabados



Thickness Espesor

6 mm

100 x 180 cm



Finish Acabado



Thickness Espesor

8 mm

100 x 100 cm

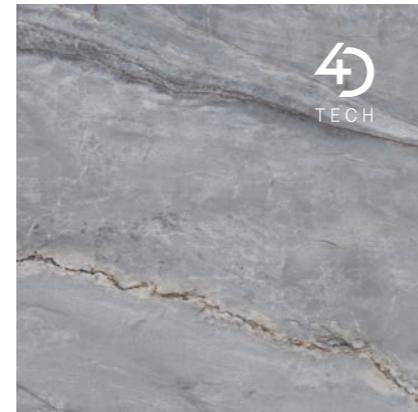

Finish Acabado



Thickness Espesor

8 mm

75,5 x 151 cm



Finishes Acabados



Thicknesses Espesores

9 mm

60 x 120 cm



Finishes Acabados



Thicknesses Espesores

9 mm





NOVA GREY PS



NOVA GREY 100X275/PS

LOUD TAUPE AS/24X151/C/R

Porcelain Porcelánico

	100x275 cm 40x109 "	100x180 cm 40x71 "	100x100 cm 40x40 "	75,5x151 cm 30x60 "	60x120 cm 24x48 "	
Thickness Espesor	6 mm	8 mm		9 mm		
Patterns Gráficas	12	12	16	20	25	
GREY	Premium Polished Shimmer (PS)	38041 M117	-	-	-	-
	Shaped (SP)	38039 M95	38034 M94	38032 M93	-	-
	Polished (EP)	-	-	-	37728 M58	37726 M40
	Natural (NT)	-	-	-	37739 M103	37734 M101
	Velvet (VV)	-	-	-	37963 M116	-

SPECIAL PIECES PIEZAS ESPECIALES

Porcelain Porcelánico (9 mm)

D. TRIGEO	30x30 cm 11.8x11.8 "			
	NOVA GREY	Polished (EP)	38134 U46	
	NOVA GREY	Natural (NT)	38132 U46	
	NOVA GREY	Velvet (VV)	38133 U46	

Porcelain Porcelánico (8 mm)

D. TRIGEO	30x30 cm 11.8x11.8 "			
	NOVA GREY	Shaped (SP)	38131 U46	

Porcelain Porcelánico (9 mm)

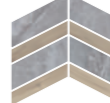
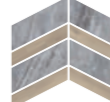
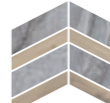
D. CHEVRON	30x21,9 cm 11.8x8.6 "			
	NOVA GREY OUD TAUPE	Polished (EP) All in One (AS)	38119 U55	
	NOVA GREY OUD TAUPE	Natural (NT) All in One (AS)	38117 U55	
	NOVA GREY OUD TAUPE	Velvet (VV) All in One (AS)	38118 U55	

TECHNICAL DATA DATOS TÉCNICOS

	DIN 51130	DIN 51097	UNE-41901 EX	BS 7976-2 (PTV)	ANSI A137.1 (DCOF)
Shaped (SP)	-	-	Class 1	-	>0,42
Natural (NT)	R10	A + B	Class 2	+36 Wet	>0,42
Velvet (VV)	-	-	Class 1	-	>0,42

150 x 320 cm



Finish Acabado



Thickness Espesor

12 mm

Porcelain Porcelánico

150x320 cm
60x126"

Thickness Espesor	12 mm
Patterns Gráficas	1
 GREY	Shaped (SP) 38019 M107



OOD

OOD interprets *oak wood* in outstanding style. Each pattern reflects oak's beauty and unique texture, with its characteristic knots and veins and a natural realism second to none.

The collection comes in a 24x151 cm format in an All in One finish, bringing seamless continuity to design projects, where it can be used both indoors and out. OOD comes in a choice of six warm colours: Greige, Taupe, Honey, Kalua, Porto and Ebony. It also features a 33.3x100 cm format for walls, which can be laid both vertically and horizontally, available in two combinations of different colours.

OOD is an exclusive collection brimming with personality, perfect for creating comfortable, sophisticated settings with that natural warmth that is so popular in architecture and interior design.

La colección OOD es una interpretación excepcional de la *madera de roble* en su máxima expresión. Cada gráfica representa la belleza y la textura única de la madera, con sus vetas y nudos característicos, ofreciendo un aspecto de lo más natural.

Se aplica en formato 24x151 cm, en el acabado All in One, para poder ofrecer continuidad en proyectos aplicándose tanto en interior como en exterior. Desarrollada sobre una paleta de color cálida, representa seis tonalidades distintas: Greige, Taupe, Honey, Kalua, Porto y Ebony. Además, cuenta con un revestimiento laminado en formato 33,3x100 cm, con dos combinaciones de colores diferentes, versátil tanto por su colocación vertical como horizontal.

OOD es exclusiva y con carácter, ideal para crear ambientes acogedores y de lo más sofisticados, que requieren de ese toque de calidez natural tanpreciado en la arquitectura y el diseño de interiores.

formats 2
formatos

colours 6
colores

finishes 2
acabados

24 x 151 cm



Greige



Taupe



Honey



Kalua

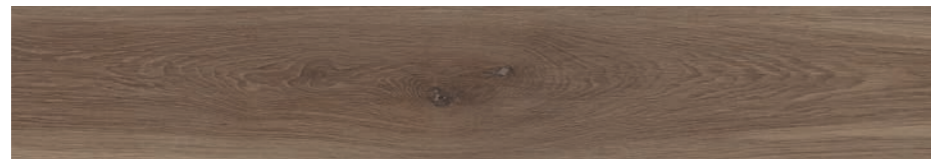

Porto



Ebony

Finish Acabado



Thickness Espesor

9 mm

33,3 x 100 cm

White body Pasta blanca



Honey & Porto

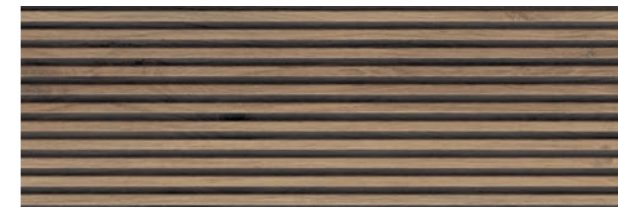

Kalua & Ebony

Finishes Acabados



Thicknesses Espesores

13,5 mm



PATTERNS VARIETY VARIEDAD GRÁFICA OUD KALUA 24x151 cm FORMAT OUD KALUA FORMATO 24x151 cm



⊖ OUD KALUA AS/24X151/C/R ⊕ SUPREME WHITE SP/150X320

















ODD HONEY PORTO DECOR SP



⊖ LINEN DESERT SP/100X100/C/R ⊕ ODD KALUA EBONY DECOR SP/33,3x100/R

		Porcelain Porcelánico	White body Pasta blanca
		24x151 cm 10x60 "	33,3x100 cm 13x40 " DECOR
Thickness Espesor		9 mm	13,5 mm
Patterns Gráficas		45	5
GREIGE	All in One (AS)	37775 M104	-
TAUPE	All in One (AS)	37776 M104	-
HONEY	All in One (AS)	37777 M104	-
KALUA	All in One (AS)	37778 M104	-
PORTO	All in One (AS)	37779 M104	-
EBONY	All in One (AS)	38044 M104	-
HONEY & PORTO	Shaped (SP)	-	37880 M97
KALUA & EBONY	Shaped (SP)	-	37879 M97

SPECIAL PIECES PIEZAS ESPECIALES

Porcelain Porcelánico (9 mm)				Porcelain Porcelánico (9 mm)			
D. TRIGEO		30x30 cm 11.8x11.8 "		D. CHEVRON		30x21,9 cm 11.8x8.6 "	
	OU D GREIGE	All in One (AS)	38145 U46		OU D GREIGE	All in One (AS)	38140 U55
	OU D TAUPE	All in One (AS)	38146 U46		OU D TAUPE	All in One (AS)	38141 U55
	OU D HONEY	All in One (AS)	38147 U46		OU D HONEY	All in One (AS)	38142 U55
	OU D KALUA	All in One (AS)	38148 U46		OU D KALUA	All in One (AS)	38143 U55
	OU D PORTO	All in One (AS)	38149 U46		OU D PORTO	All in One (AS)	38144 U55
	OU D EBONY	All in One (AS)	38150 U46		OU D EBONY	All in One (AS)	38139 U55

TECHNICAL DATA DATOS TÉCNICOS

	DIN 51130	DIN 51097	UNE-41901 EX	BS 7976-2 (PTV)	ANSI A137.1 (DCOF)
All in One (AS)	R11	A + B + C	Class 3	+36 Wet	>0,42

SUBLIME *vulcano*

Vulcano reminds us of *Calacatta Black*, a fancy name for a type of marble from North Africa. Characterized by a black background with warm shades and strong white veins, this marble has great charm and lends itself well to wall or floor applications. The production of natural *Calacatta Black* is very limited. Its white and brown veining helps us to combine it, both for a classic black and white with Iceberg, as well as with Thunder or Cliff.

The collection comes now in a 100x275 cm, 100x180 cm, 100x100 cm, 75,5x151 cm or 60x120 cm format, in a choice of a Premium Polished, Shaped, Polished or Natural finish.

Vulcano nos recuerda a *Calacatta Black*, un nombre de fantasía para un tipo de mármol procedente del norte de África. Caracterizado por un fondo negro con sombras cálidas y fuertes vetas blancas, este mármol tiene un gran encanto y se presta bien en aplicaciones de revestimiento o pavimento. La producción de *Calacatta Black* natural es muy limitada. Su veteado blanco y marrón nos ayuda a la combinabilidad, tanto para un clásico blanco y negro con Iceberg, como con Thunder o Cliff.

Ahora disponible en formatos 100x275 cm, 100x180 cm, 100x100 cm, y también en 75,5x151 cm y 60x120 cm. En acabados Premium Polished, Shaped, Polished y Natural.

formats 5
formatos

colours 1
colores

finishes 4
acabados

100 x 275 cm

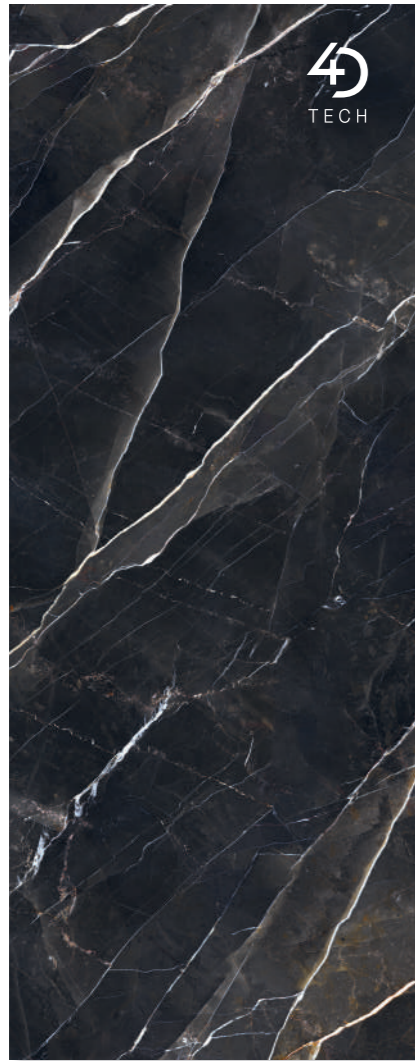

Finishes Acabados



Thickness Espesor

6 mm

100 x 180 cm



Finish Acabado



Thickness Espesor

8 mm

100 x 100 cm



Finish Acabado



Thickness Espesor

8 mm

75,5 x 151 cm



Finishes Acabados



Thicknesses Espesores

9 mm

60 x 120 cm

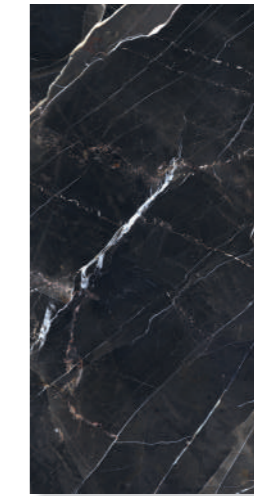

Finishes Acabados





Thicknesses Espesores

9 mm

This collection has been extended with Shaped finish formats: 100x275, 100x180 and 100x100 cm.
Esta colección se ha ampliado con los formatos de acabado Shaped: 100x275, 100x180 y 100x100 cm.





Porcelain Porcelánico					
	100x275 cm 40x109 "	100x180 cm 40x71 "	100x100 cm 40x40 "	75,5x151 cm 30x60 "	60x120 cm 24x48 "
Thickness Espesor	6 mm	8 mm		9 mm	
Patterns Gráficas	5	9	15	15	20
 Premium Polished (P)	36269 M88	-	-	-	-
 Shaped (SP)	36265 M95	36255 M94	36249 M93	-	-
Polished (EP)	-	-	-	36244 M74	36240 M73
Natural (NT)	-	-	-	36248 M103	36235 M101

SPECIAL PIECES PIEZAS ESPECIALES

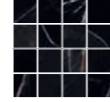
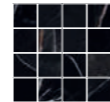
Porcelain Porcelánico (9 mm)

D. MOSAIC	30x30 cm 11.8x11.8 "		
	SUBLIME VULCANO	Polished (EP)	36855 U36
	SUBLIME VULCANO	Natural (NT)	36854 U36

Porcelain Porcelánico (9 mm)

* D. MIX	30x30 cm 11.8x11.8 "		
	SUBLIME ICEBERG SUBLIME THUNDER SUBLIME VULCANO	Natural (NT)	36858 U51
	SUBLIME ICEBERG SUBLIME THUNDER SUBLIME VULCANO	Polished (EP)	36860 U51

* Random colour position.
* Posición de colores aleatoria.

TECHNICAL DATA DATOS TÉCNICOS

	DIN 51130	DIN 51097	UNE-41901 EX	BS 7976-2 (PTV)	ANSI A137.1 (DCOF)
Shaped (SP)	-	-	Class 1	-	>0,42
Natural (NT)	R10	A + B	Class 2	+36 Wet	>0,42

supreme

SUPREME is a collection that unites stylish elegance with a strong design appeal. Inspired by select pieces of *Invisible Blue marble*, its bluish-grey surface veining contrasts with the white background, lending each of the tiles a personality. One special peculiarity are the additional effects of the collection's Shaped finish, further enhancing its striking veined pattern, with end results that surpass those of the real marble.

Now available in a 150x320 cm Shaped finish to complete the SUPREME collection, that allows to create 'total-look' spaces, elevating the concept of sophistication to new levels.

SUPREME es la colección donde el diseño y la elegancia se aúnan para sorprendernos. Inspirada en la versión más exclusiva del *mármol Invisible Blue*, representa una superficie de tonos grises azulados, que contrastan sobre su base blanca, proporcionándole carácter y personalidad a cada una de sus piezas. Con la particularidad del acabado Shaped, que introduce efectos márficos que realzan todavía más su bella gráfica vetada, ofreciendo una composición que supera la propia naturaleza del mármol original.

Ahora disponible en 150x320 cm en acabado Shaped, para completar la colección SUPREME, que permite crear espacios 'total look', creando así espacios donde la sofisticación alcanza su máxima expresión.

new formats 1
nuevos formatos

colours 1
colores

finishes 1
acabados

150 x 320 cm



Book Match design available.
Diseño Book Match disponible.

Finish Acabado



Thickness Espesor

12 mm

		Porcelain Porcelánico		
		150x320 cm 60x126"		BOOK MATCH
Thickness Espesor		12 mm	12 mm	
Patterns Gráficas		2	A	B
	WHITE Shaped (SP)	38046 M108	38017 M108	38018 M108





MUSEUM BATH

MUSEUM aspires to help create unique exclusive settings, developing products conceived to meet consumer needs and to fit in with the latest trends. With this in mind, we have created an extensive range of washbasin units with a strong design appeal, bringing the very essence of MUSEUM to a selection of exclusive models.

The minimalist design with the versatile character of these new sinks makes them ideal for its integration in space. Models that combine design and functionality adapting to the needs of each bathroom.

The variety of MUSEUM collections promotes the customization of washbasins. You can choose from a wide range of 6 mm thick products, in Shaped and Natural finishes.

El deseo de MUSEUM es llegar a ofrecer espacios únicos y exclusivos, desarrollando proyectos que se adapten a las necesidades del cliente y que reflejen las nuevas tendencias. Para ello, apostamos por crear una amplia gama de baño con elementos de diseño, llevando la esencia de MUSEUM a diferentes y exclusivas composiciones.

El diseño minimalista junto al carácter versátil de estos nuevos lavabos favorece su integración en el espacio. Modelos que combinan diseño y funcionalidad adaptándose a las necesidades de cada baño.

La variedad de colecciones MUSEUM favorece la personalización de los lavabos. Puede elegir entre una gran diversidad de productos de 6 mm de espesor, en los acabados Shaped y Natural.

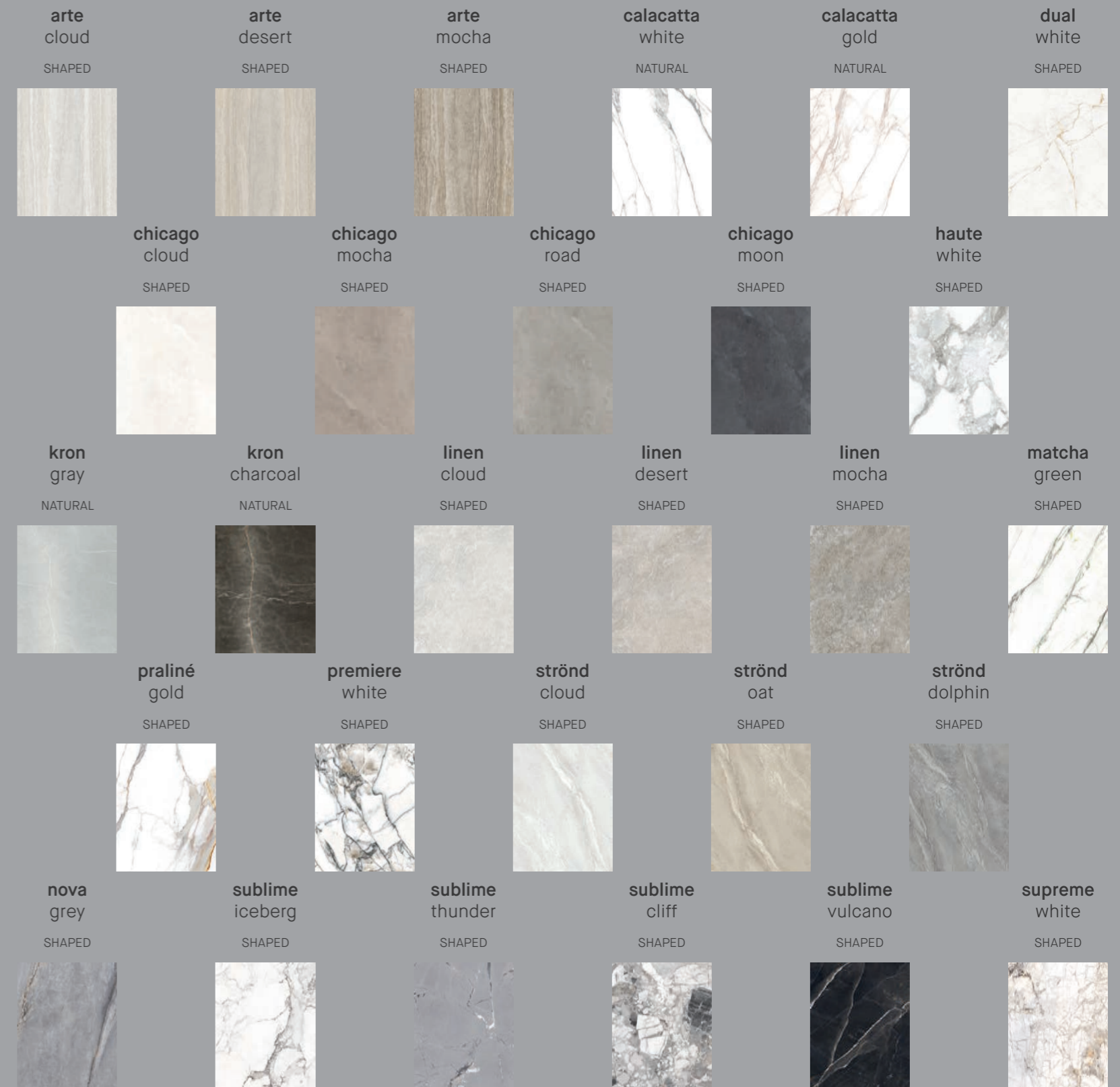

NEW

TOTEM

50

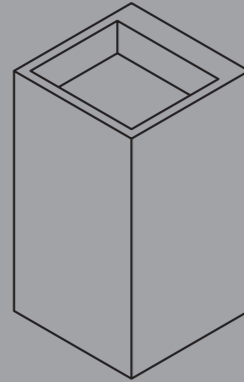

TOTAL MEASURES (LxA×H)
MEDIDAS TOTALES (LxA×H)

500 x 500 x 900 mm

SINK MEASURES (LxA×H)
MEDIDAS DE SENO (LxA×H)

430 x 370 x 95 mm

SINK OPTIONS
OPCIONES DE SENO

1 sink (SC)
1 seno (SC)

PRICE RATES
CÓDIGOS DE PRECIO

MB13



PRIMARY

160

120

80

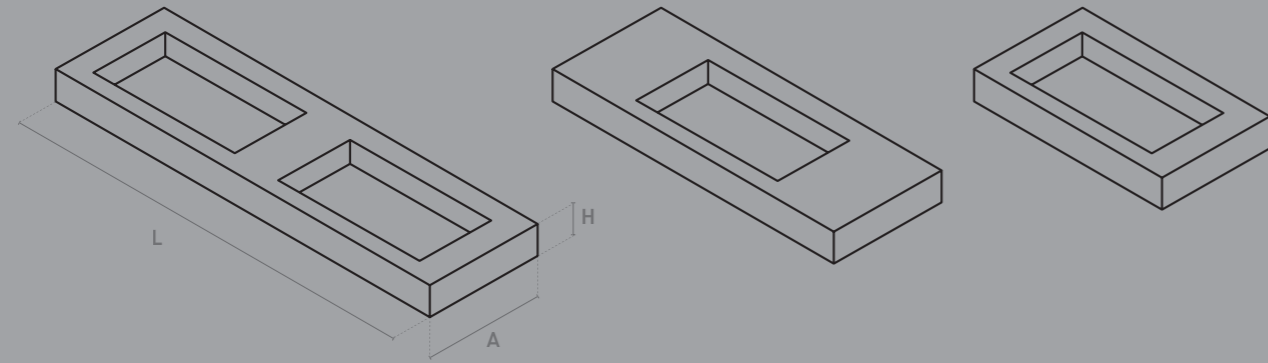

INCLINED

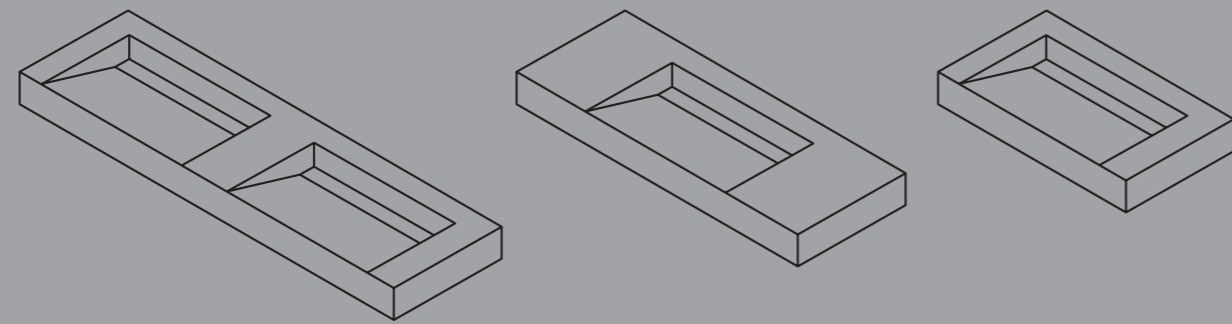

TOTAL MEASURES (LxA×H)
MEDIDAS TOTALES (LxA×H)

1600 x 455 x 120 mm	1200 x 455 x 120 mm	800 x 455 x 120 mm
---------------------	---------------------	--------------------

PRIMARY SINK MEASURES (LxA×H)
MEDIDAS DE SENO PRIMARY (LxA×H)

600 x 300 x 95 mm	600 x 300 x 95 mm	600 x 300 x 95 mm
-------------------	-------------------	-------------------

INCLINED SINK MEASURES (LxA×H)
MEDIDAS DE SENO INCLINED (LxA×H)

600 x 360 x 95 mm	600 x 360 x 95 mm	600 x 360 x 95 mm
-------------------	-------------------	-------------------

SINK OPTIONS
OPCIONES DE SENO

2 sinks (SS) 2 senos (SS)	1 sink (SI/SC/SD) <i>(location can be chosen)</i> 1 seno (SI/SC/SD) <i>(posición elegible)</i>	1 sink (SC) 1 seno (SC)
------------------------------	---	----------------------------

MOUNTING BRACKETS
ESCUADRAS DE MONTAJE

4 brackets 4 escuadras	2 brackets 2 escuadras	2 brackets 2 escuadras
---------------------------	---------------------------	---------------------------

PRICE RATES
CÓDIGOS DE PRECIO
(without brackets set)
(sin juego de escuadras)

MB1	MB2	MB3
-----	-----	-----

(with brackets set)
(con juego de escuadras)

MB4	MB5	MB6
-----	-----	-----

NEW

SHELF

160

120

80

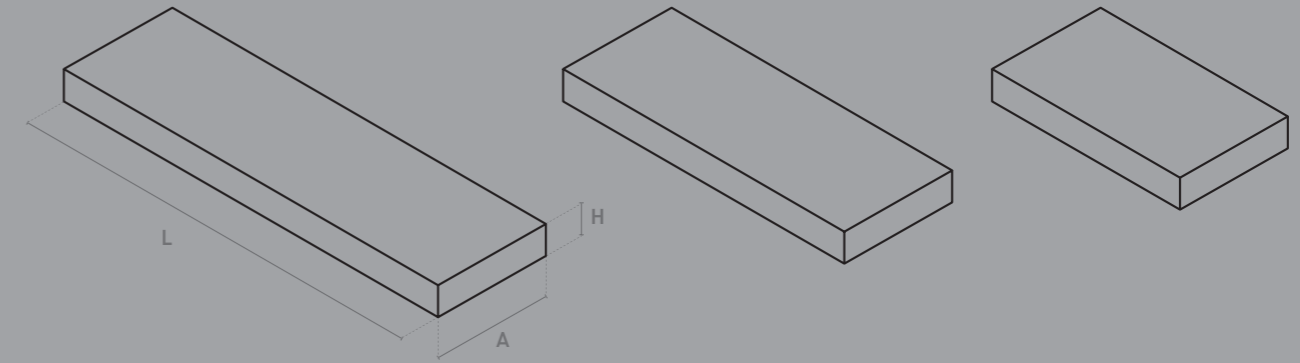

TOTAL MEASURES (LxA×H)
MEDIDAS TOTALES (LxA×H)

1600 x 455 x 120 mm	1200 x 455 x 120 mm	800 x 455 x 120 mm
---------------------	---------------------	--------------------

MOUNTING BRACKETS
ESCUADRAS DE MONTAJE

4 brackets 4 escuadras	2 brackets 2 escuadras	2 brackets 2 escuadras
---------------------------	---------------------------	---------------------------

PRICE RATES
CÓDIGOS DE PRECIO
(without brackets set)
(sin juego de escuadras)

MB7	MB8	MB9
-----	-----	-----

(with brackets set)
(con juego de escuadras)

MB10	MB11	MB12
------	------	------

Tap Options Opciones de Grifo

Taps are not included. If needed, custom holes for taps or water drain can be requested.

Grifería no incluida. De ser necesarios, se pueden incorporar agujeros a medida para grifos o desagüe.

Sink Options Opciones de Seno

In both PRIMARY and INCLINED 120 washbasins, the sink location can be chosen: left (SI), center (SC) or right (SD). 160 models have always two sinks (SS). 80 models have always one centered sink (SC).

En los lavabos 120, tanto PRIMARY como INCLINED, se puede elegir la posición del seno: a la izquierda (SI), centrado (SC) o a la derecha (SD). Los modelos 160 siempre tienen doble seno (SS). Los modelos 80 siempre tienen un seno centrado (SC).

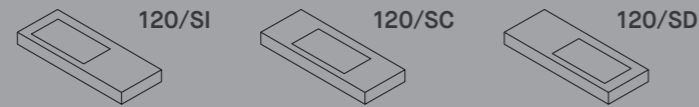

Mounting Brackets Escuadras de Montaje

If desired, MUSEUM BATH can be installed suspended on the wall using wall mount brackets. For the correct installation, it is recommended taking into account the approximate furniture weights indicated. We provide the mounting brackets for an additional fee (1 set = 2 wall mount brackets). 160 model requires 2 sets, while 120 and 80 models require only 1 set.

Si lo desea, MUSEUM BATH puede instalarse suspendido en pared usando escuadras de montaje para pared. Para la correcta instalación, se recomienda tener en cuenta los pesos aproximados del mueble. Proporcionamos las escuadras con una tarifa adicional (1 juego = 2 escuadras de montaje para pared). El modelo 160 necesita 2 juegos, mientras que los modelos 120 y 80 necesitan solamente 1 juego.

TOTAL MEASURES (L×H×A) 433 x 100 x 90 mm
MEDIDAS TOTALES (L×H×A)

SET WEIGHT 4,96 lb
PESO DEL JUEGO 2,25 kg

SET PRICE RATE U80
PRECIO DEL JUEGO

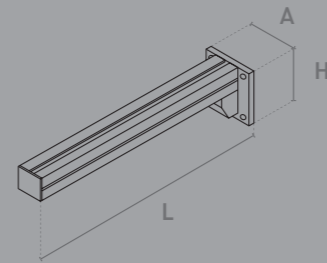

Packing Embalaje

MODEL MODELO	SIZE FORMATO	BOX CAJA		PALLET PALET		
		Units Piezas	lb kg	Boxes Cajas	lb kg	Approx. inch. sizes Tamaño aprox. cm.
160	63 x 17.9 x 4.72 1600 x 455 x 120	1	112.4 51	4	449.7 204	70.9 x 35.4 x 31.9 180 x 90 x 81
120	47.2 x 17.9 x 4.72 1200 x 455 x 120	1	101.4 46	4	405.7 184	47.3 x 31.5 x 31.9 120 x 80 x 81
80	31.5 x 17.9 x 4.72 800 x 455 x 120	1	72.8 33	4	291 132	47.3 x 31.5 x 31.9 120 x 80 x 81

COMPLEMENTARY PIECES PIEZAS COMPLEMENTARIAS

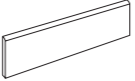
S.K.I. S.K.D.		SKIRTING				
		8x30 cm 3.1x11.8 "				
Premium Polished Shimmer (PS)	U53	8x100 cm 3.1x39.4 "	8x90 cm 3.1x35.4 "	8x75,5 cm 3.1x29.7 "	8x60 cm 3.1x23.6 "	
Premium Polished (P)	U53	Premium Polished Shimmer (PS)	U48	-	-	-
Shaped (SP)	U53	Premium Polished (P)	U48	-	-	-
Antislip (A)	U53	Shaped (SP)	U45	U44	U43	U35
Polished (EP)	U53	Antislip (A)	-	U44	-	-
Natural (NT)	U53	Polished (EP)	-	-	U43	U35
Velvet (VV)	U53	Natural (NT)	-	U44	U43	U35
All in One (AS)	U53	Velvet (VV)	-	-	U43	-
		All in One (AS)	-	U44	U43	U35

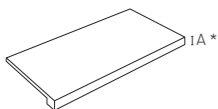
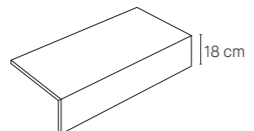
STAIR TREADS								
TECHNICAL (PT)	SEAMLESS (PL/18)							
		30x180 cm 11.8x70.8 "	30x151 cm 11.8x59.4 "	30x120 cm 11.8x47.2 "	30x100 cm 11.8x39.4 "	30x90 cm 11.8x35.4 "	30x75,5 cm 11.8x29.7 "	30x60 cm 11.8x23.6 "
Premium Polished Shimmer (PS)		-	-	-	U74	-	-	-
Premium Polished (P)		U90	-	-	U74	-	-	-
Shaped (SP)		U90	U86	U75	U74	U76	U76	U54
Antislip (A)		-	-	-	-	U76	-	-
Polished (EP)		-	U86	U75	-	-	U76	U54
Natural (NT)		-	-	-	-	-	U76	U54
Velvet (VV)		-	U86	U75	-	-	-	-
All in One (AS)		-	U86	U75	-	U76	U76	U54

* When thickness is 6 mm, A = 18 mm; when 8 mm, A = 24 mm; when 9 mm, A = 27 mm.
* Cuando el espesor es 6 mm, A = 18 mm; si es 8 mm, A = 24 mm; si es 9 mm, A = 27 mm.

POOL PIECES PIEZAS DE PISCINA

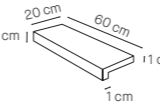
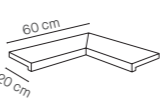
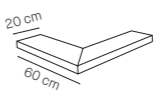
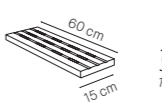
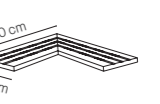
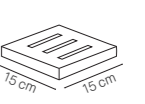
		Porcelain Porcelánico					
							
		P.V. (POOL COPING) 20x60x0,9 cm 8x23.6x0.35 "	ANG.P.V. (POOL COPING INTERNAL CORNER) 60x60x0,9 cm 23.6x23.6x0.35 "	E.P.V. (POOL COPING EXTERNAL CORNER) 60x60x0,9 cm 23.6x23.6x0.35 "	RE.J. (DRAINAGE GRATE) 15x60x2 cm 6x23.6x0.8 "	ANG.RE.J. (ANGLE CORNER DRAINAGE GRATE) 60x60x2 cm 23.6x23.6x0.8 "	T.RE.J. (SQUARE CORNER DRAINAGE GRATE) 15x15x2 cm 6x6x0.8 "
LINEN CLOUD	All in One (AS)	38434 U61	38441 U70	38444 U70	38460 U54	38463 U75	38466 M71
LINEN DESERT	All in One (AS)	38435 U61	38442 U70	38445 U70	38461 U54	38464 U75	38467 M71
LINEN MOCHA	All in One (AS)	38436 U61	38443 U70	38446 U70	38462 U54	38465 U75	38468 M71
LOUD GREIGE	All in One (AS)	38487 U61	38507 U70	38513 U70	38520 U54	38526 U75	38533 U71
LOUD TAUPE	All in One (AS)	38488 U61	38508 U70	38514 U70	38521 U54	38527 U75	38534 U71
LOUD HONEY	All in One (AS)	38489 U61	38509 U70	38515 U70	38522 U54	38528 U75	38535 U71
LOUD KALUA	All in One (AS)	38490 U61	38510 U70	38516 U70	38523 U54	38529 U75	38536 U71
LOUD PORTO	All in One (AS)	38491 U61	38511 U70	38517 U70	38524 U54	38530 U75	38537 U71
LOUD EBONY	All in One (AS)	38492 U61	38512 U70	38518 U70	38525 U54	38531 U75	38532 U71

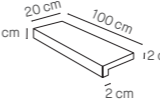
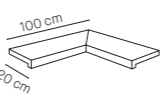
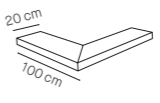
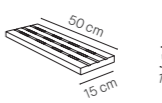
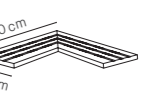
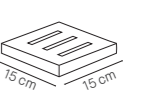
		Porcelain Porcelánico					
							
		P.V. (POOL COPING) 20x100x2 cm 8x39.4x0.8 "	ANG.P.V. (POOL COPING INTERNAL CORNER) 100x100x2 cm 39.4x39.4x0.8 "	E.P.V. (POOL COPING EXTERNAL CORNER) 100x100x2 cm 39.4x39.4x0.8 "	RE.J. (DRAINAGE GRATE) 15x50x2 cm 6x19.7x0.8 "	ANG.RE.J. (ANGLE CORNER DRAINAGE GRATE) 50x50x2 cm 19.7x19.7x0.8 "	T.RE.J. (SQUARE CORNER DRAINAGE GRATE) 15x15x2 cm 6x6x0.8 "
LINEN CLOUD	Antislip (A)	38469 M82	38472 M86	38475 M86	38478 M54	38481 M86	38484 M71
LINEN DESERT	Antislip (A)	38470 M82	38473 M86	38476 M86	38479 M54	38482 M86	38485 M71
LINEN MOCHA	Antislip (A)	38471 M82	38474 M86	38477 M86	38480 M54	38483 M86	38486 M71

FLOOR AND WALL TILES PAVIMENTO Y REVESTIMIENTO

SIZE FORMATO	BOX CAJA			PALLET PALET				CONTAINER 20' (25000 KG.)		
	cm.	Piezas	m ²	kg	Cajas	m ²	kg	Tamaño aprox. cm.	Palets	m ²
100 x 180 x 0,8	2	3,6	70,88	18	64,8	1326	190 x 115 x 60	17	1101,6	22539,3
100 x 100 x 0,8	2	2	36,8	32	64	1340	112 x 112 x 100	18	1152	24118,6
100 x 100 x 2	1	1	49,2	24	24	1223	112 x 112 x 85	20	480	24456
75,5 x 151 x 0,9	2	2,28	47,16	27	61,56	1298	156 x 93 x 76	18	1108	23370
24 x 151 x 0,9	3	1,09	22,31	48	52,32	1096	156 x 93 x 63	18	942	19726
60 x 120 x 0,9	2	1,44	30,2	30	43,2	930	120 x 80 x 75	26	1123	24180
90 x 90 x 0,9	2	1,62	33,96	24	38,88	839	105 x 95 x 75	29	1128	24332
33,3 x 100 x 1,05	4	1,33	24	48	63,84	1177	118 x 110 x 81	20	1276,8	23540
33,3 x 100 x 1,35	3	1	21,92	48	48	1077	118 x 110 x 81	20	960	21543,2
inch.	Units	ft ²	lb	Boxes	ft ²	lb	Approx. inch. sizes	Pallets	ft ²	lb
39.4 x 70.8 x 0.32	2	38.75	156.26	18	697.5	2924	71.2 x 44.1 x 25.2	17	11857.5	49691
39.4 x 39.4 x 0.32	2	21.53	81.13	32	688.9	2955	44.1 x 44.1 x 39.4	18	12400	53172.3
39.4 x 39.4 x 0.79	1	10.76	108.47	24	258.3	2696	44.1 x 44.1 x 33.5	20	5166.7	53916.3
29.7 x 59.4 x 0.35	2	24.5	103.97	27	662.6	2862	61.4 x 36.6 x 29.9	18	11926.4	51522
9.45 x 59.4 x 0.35	3	11.73	49.18	48	563.17	2416	61.4 x 36.6 x 24.83	18	10139.6	43488.4
23.6 x 47.2 x 0.35	2	15.5	66.6	30	465	2051	47.2 x 31.4 x 29.5	26	12087.9	53307.8
35.4 x 35.4 x 0.35	2	17.44	74.87	24	418.5	1850	41.3 x 37.4 x 29.5	29	12141.7	53643
13.11 x 39.4 x 0.41	4	14.32	52.91	48	687.2	2595	46.4 x 43.3x 31.8	20	13743.4	51897
13.11 x 39.4 x 0.53	3	10.76	48.33	48	516.7	2375	46.4 x 43.3x 31.8	20	10333.4	47494

SLABS PLACAS

1 SLAB 1 PLACA			WOODEN CRATE CAJ. MADERA			CONTAINER 20' (25000 KG.)			CONTAINER 40' (25000 KG.)		
cm.	m ²	kg	Placas	m ²	kg	Cajones	m ²	kg	Cajones	m ²	kg
100 x 275 x 0,6	2,75	38,5	20	55	869	24	1320	20856	28	1540	24332
inch.	ft ²	lb	Slabs	ft ²	lb	Crates	ft ²	lb	Crates	ft ²	lb
39,4 x 108,3 x 0,24	29,6	84.88	20	592	1916	24	14208.4	45980	28	16576.4	53643

1 SLAB 1 PLACA			A-FRAME CABALLETE			CONTAINER 20' (25000 KG.)			CONTAINER 40' (25000 KG.)		
cm.	m ²	kg	Placas	m ²	kg	Caballote	m ²	kg	Caballote	m ²	kg
100 x 275 x 0,6	2,75	38,5	50	137,5	2024	6	825	12144	11	1512,5	22264
inch.	ft ²	lb	Slabs	ft ²	lb	A-frame	ft ²	lb	A-frame	ft ²	lb
39,4 x 108,3 x 0,24	29,6	84.88	50	1480	4343	6	8880	26058	11	16280	47773

WOODEN CRATE CAJÓN DE MADERA

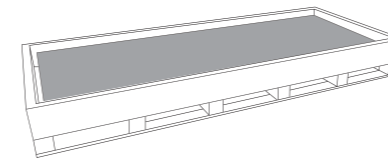

Tamaño aprox. cm.
291 x 112 x 33 cm
Approx. inch. sizes
114.6 x 44 x 13 "

A-FRAME CABALLETE

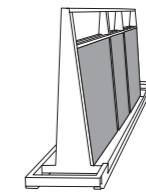

Tamaño aprox. cm.
291 x 150 x 75 cm
Approx. inch. sizes
114.6 x 59 x 29.5 "

WORKTOPS ENCIMERAS

1 WORKTOP 1 ENCIMERA			A-FRAME CABALLETE METAL			CONTAINER 20' (25000 KG.)			CONTAINER 40' (25000 KG.)		
cm.	m ²	kg	Placas	m ²	kg	Caballote	m ²	kg	Caballote	m ²	kg
150 x 320 x 1,2	4,8	150	20	96	3190	3	288	9570	7	672	22330
inch.	ft ²	lb	Slabs	ft ²	lb	A-frame	ft ²	lb	A-frame	ft ²	lb
59 x 126 x 0,47	51.66	330	20	1033	7033	3	3100	21099	7	7231	49231

1 WORKTOP 1 ENCIMERA			WOODEN BUNDLE CAB. MADERA			CONTAINER 20' (25000 KG.)			CONTAINER 40' (25000 KG.)		
cm.	m ²	kg	Placas	m ²	kg	Paquete	m ²	kg	Paquete	m ²	kg
150 x 320 x 1,2	4,8	150	20	96	3000	7	672	21000	7	672	21000
inch.	ft ²	lb	Slabs	ft ²	lb	Bundle	ft ²	lb	Bundle	ft ²	lb
59 x 126 x 0,47	51.66	330	20	1033	6614	7	7231	46297	7	7231	46297

A-FRAME CABALLETE DE METAL



Tamaño aprox. cm.
330 x 195 x 75 cm
Approx. inch. sizes
129.9 x 76.8 x 29.5 "

WOODEN BUNDLE CABALLETE MADERA

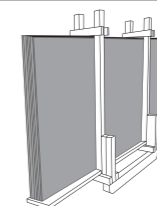

Tamaño aprox. cm.
330 x 195 x 55 cm
Approx. inch. sizes
129.9 x 76.8 x 21.7 "

MUSEUM

Once ceramic tiles reach the end of their useful life, they are inert waste. For their proper management, they should be given to an authorized waste management body for recycling purposes.

All colours and hues appearing in this catalogue should be considered approximate, only in view of the printing processes involved. The rights of all contents (texts, photographs, drawings, designs, etc.) of this catalogue remain the property of PERONDA GROUP S.A (or, failing that, they have the corresponding permissions of the owners). No part of this publication may be reproduced, stored in a retrieval system, or transmitted in any form or by any means, electronic, mechanical, photocopying, recording or otherwise, without the prior written permission of the copyright holders.

© PERONDA GROUP 2023

Las baldosas cerámicas una vez que llegan al final de su vida útil son un residuo inerte, que para su correcta gestión debe ser entregado a un gestor autorizado de residuos, favoreciendo su reciclado.

Debido a los procesos de impresión, los colores que aparecen en este catálogo deben considerarse aproximados, y no exactos. Los derechos de todos los contenidos (textos, fotografías, dibujos, diseños etc) del presente catálogo son propiedad de PERONDA GROUP, S.A (o en su defecto, cuentan con los correspondientes permisos y autorizaciones de sus titulares). No está permitida la reproducción total o parcial de esta publicación, ni su tratamiento informático, ni la transmisión de ninguna forma o por cualquier medio, ya sea electrónico, mecánico, por fotocopia, por registro u otros medios, sin el permiso previo y por escrito de los titulares del copyright.

Av. Manuel Escobedo, 26
12200 Onda (Castellón) Spain
+34 964 602 012

museumsurfaces.com